

A

B

C

D

E

F

REV	ECN No.	DESCRIPTION	DESIGN	DATE
A	-	NEW RELEASE	吴丹平	2015.07.01

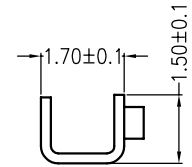
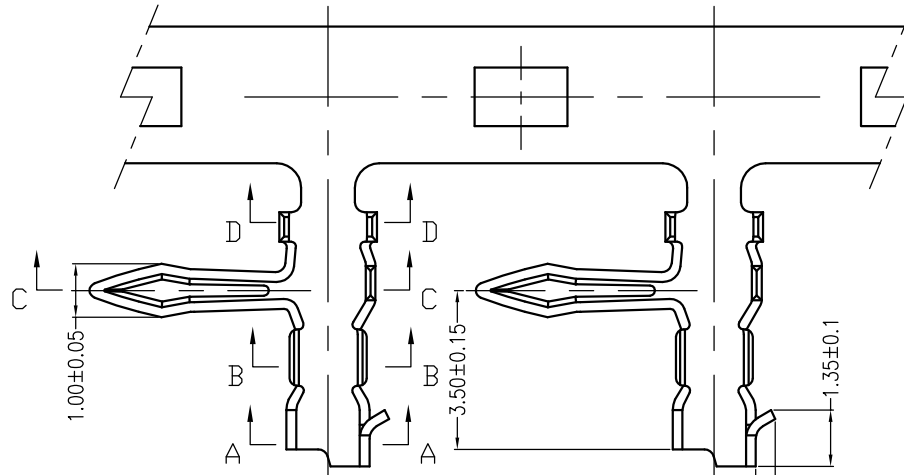
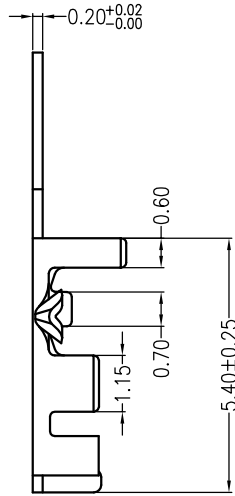

A-A

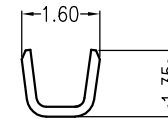

B-B

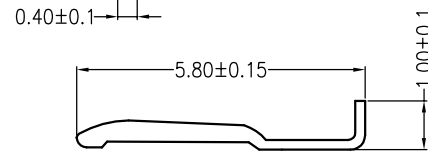

C-C

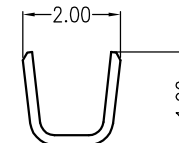

D-D

备注:



1. 材质: 磷青铜
2. 电镀表面处理: 光亮锡
3. 冲制件表面应光洁平整无毛刺及裂痕;
4. 零件折弯处不得有机械损伤, 切口处毛刺 <0.03 ;
5. 材料有害物质控制需符合RoSH标准。
6. 物料说明:

Ordering Information & Specification:

Part No	Wire Range	Insulation O.D.	Material	Finish	Qty/Reel
B2002T-PA	AWG #22~#30	1.30mm(max)	Phosphor bronze	Tin-plated	12,000 pcs

 东莞市高迪电子有限公司
DONG GUAN GAO DI ELECTRONICS CO., LTD

TITLE: -

X.±0.2	X.±0.5°	USE:	PART NO.:
.X±0.10	.X±0.3°	MANUFACTURE	
.XX±0.05	.XX±0.2°	APPD:	B2002端子
--	--	邵敬和	DWG NO.:
		CHKD:	GCDZ-0019
UNITS:	DR: 吴丹平	田峰	SCALE
mm			1 : 1
			SHEET
			1 / 1

A

B

C

D

E

F

REV	DESIGN	DATE
A0	吴丹平	2017.03.23
-	-	-

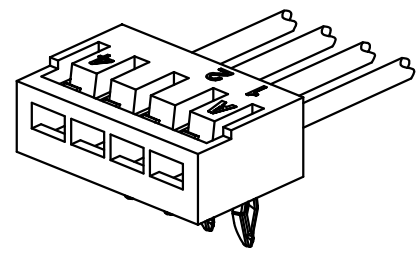
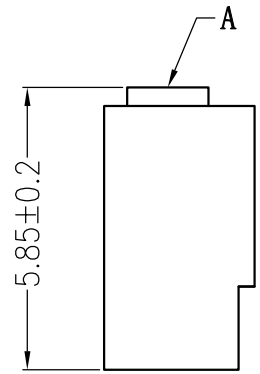
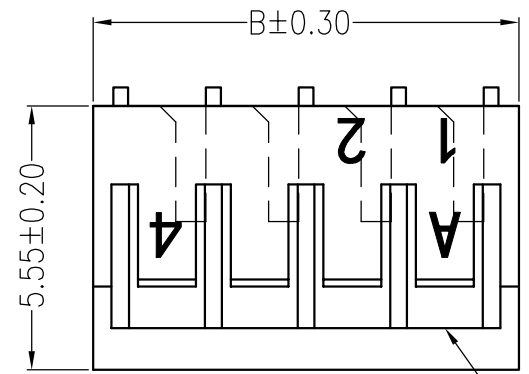

主要技术参数 Main Specifications

- 线 数 (Poles): 02 to 16
- 接触电阻 (Contact resistance): $\leq 20m\Omega$
- 绝缘电阻 (Insulation resistance): $\geq 1000M\Omega$
- 额定电压 (Rated voltage): 250V AC DC
- 额定电流 (Rated current): 2.0A AC DC
- 耐 电压 (Withstand Voltage): 800V AC/minute
- 温度范围 (Temperature Range) : $-25^{\circ}C \sim +85^{\circ}C$

ORDER INFORMATION:

B2002Y--A6W-P**

PART No.	No. OF CIRCUITS:	PACKAGING: P=PE PLASTIC MATERIAL: A6W=PA66 (WHITE)
02~13		

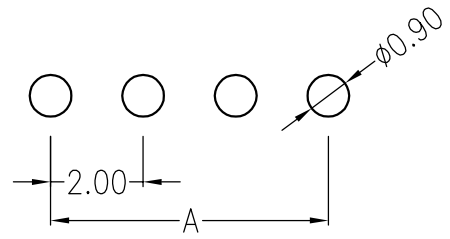
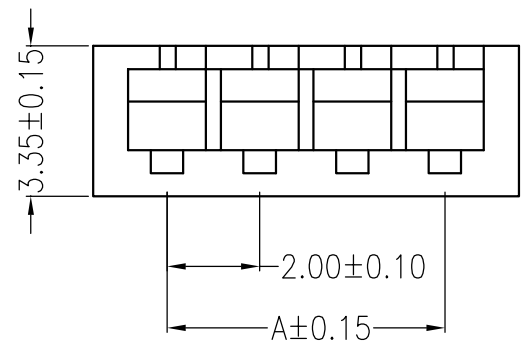

SUGGESTED PCB LAYOUT
(COMPONENT SIDE)

Circuits	Dimensions (mm)	
	A	B
02	2.00	4.70
03	4.00	6.70
04	6.00	8.70
05	8.00	10.70
06	10.00	12.70
07	12.00	14.70
08	14.00	16.70
09	16.00	18.70
10	18.00	20.70
11	20.00	22.70
12	22.00	24.70
13	24.00	26.70
14	26.00	28.70

ITEM	COMPONENT	Q'TY	MATERIAL	FINISH
A	HOUSING	1 PCS	PA66	UL 94V-0, COLOR:WHITE
东莞市高迪电子有限公司 DONG GUAN GAO DI ELECTRONICS CO., LTD				
TITLE: -				2.00mm PITCH 90°HOUSING
PART NO.:				B2002Y-**-A6W-P
DWG NO.:				GCKH-0586
SCALE		SHEET		
1 : 1		1 / 1		

东莞市高迪电子有限公司
DONG GUAN GAO DI ELECTRONICS CO., LTD

USE: CUSTOMER
 APPD: 邵敬和
 CHKD: 曾令青
 DR: 蒋建银
 UNITS: mm